

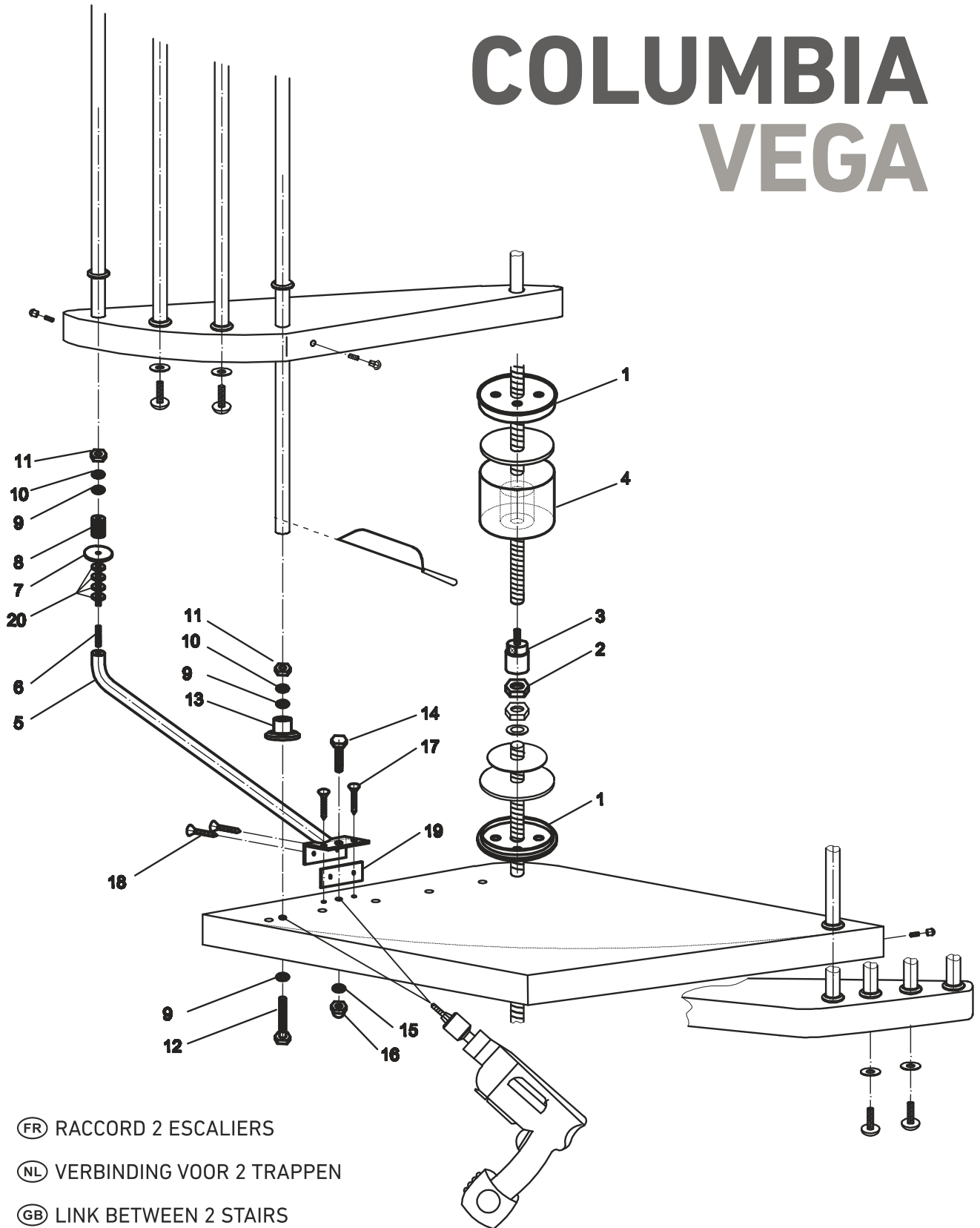

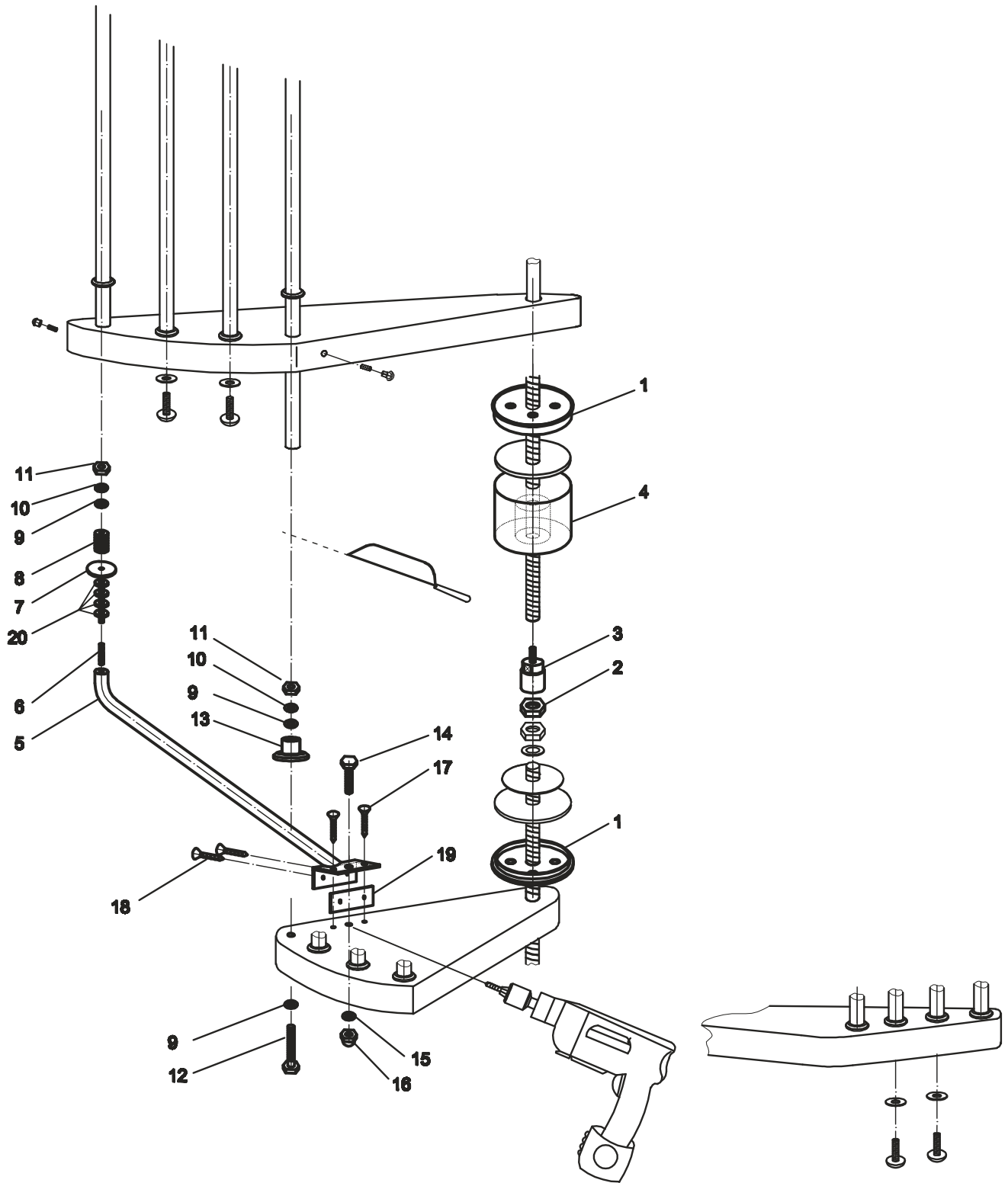













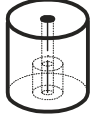
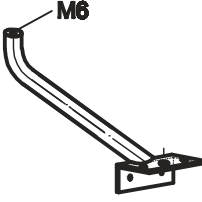





# COLUMBIA VEGA



- (FR) RACCORD 2 ESCALIERS
- (NL) VERBINDING VOOR 2 TRAPPEN
- (GB) LINK BETWEEN 2 STAIRS
- (DE) VERBINDUNG 2 TREPPEN
- (ES) EMPALME PARA 2 ESCALERAS
- (RO) RACORD ÎNTRE 2 SCĂRI



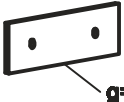

<p>①</p>  <p>=2</p>	<p>②</p>  <p>M20</p> <p>=1</p>	<p>③</p>  <p>M12</p> <p>M20</p> <p>=1</p>	<p>④</p>  <p>L=157</p> <p>=1</p>	<p>⑤</p>  <p>M6</p> <p>=1</p>	<p>⑥</p>  <p>M6-75</p> <p>=1</p>
<p>⑦</p>  <p>=1</p>	<p>⑧</p>  <p>=1</p>	<p>⑨</p>  <p>A6</p> <p>=3</p>	<p>⑩</p>  <p>N6</p> <p>=2</p>	<p>⑪</p>  <p>M6</p> <p>=2</p>	<p>⑫</p>  <p>M6-70</p> <p>=1</p>
<p>⑬</p>  <p>=1</p>	<p>⑭</p>  <p>M8-50</p> <p>=1</p>	<p>⑮</p>  <p>A8</p> <p>=1</p>	<p>⑯</p>  <p>M8</p> <p>=1</p>	<p>⑰</p>  <p>Ø5-25</p> <p>=2</p>	<p>⑱</p>  <p>Ø5-40</p> <p>=2</p>
<p>⑲</p>  <p>g=4</p> <p>=0 → Vega 120 =1 → Vega 140</p>	<p>⑳</p>  <p>g=5</p> <p>=0 → h=205 mm =1 → h=210 mm =2 → h=215 mm =3 → h=220 mm =4 → h=225 mm</p>				